

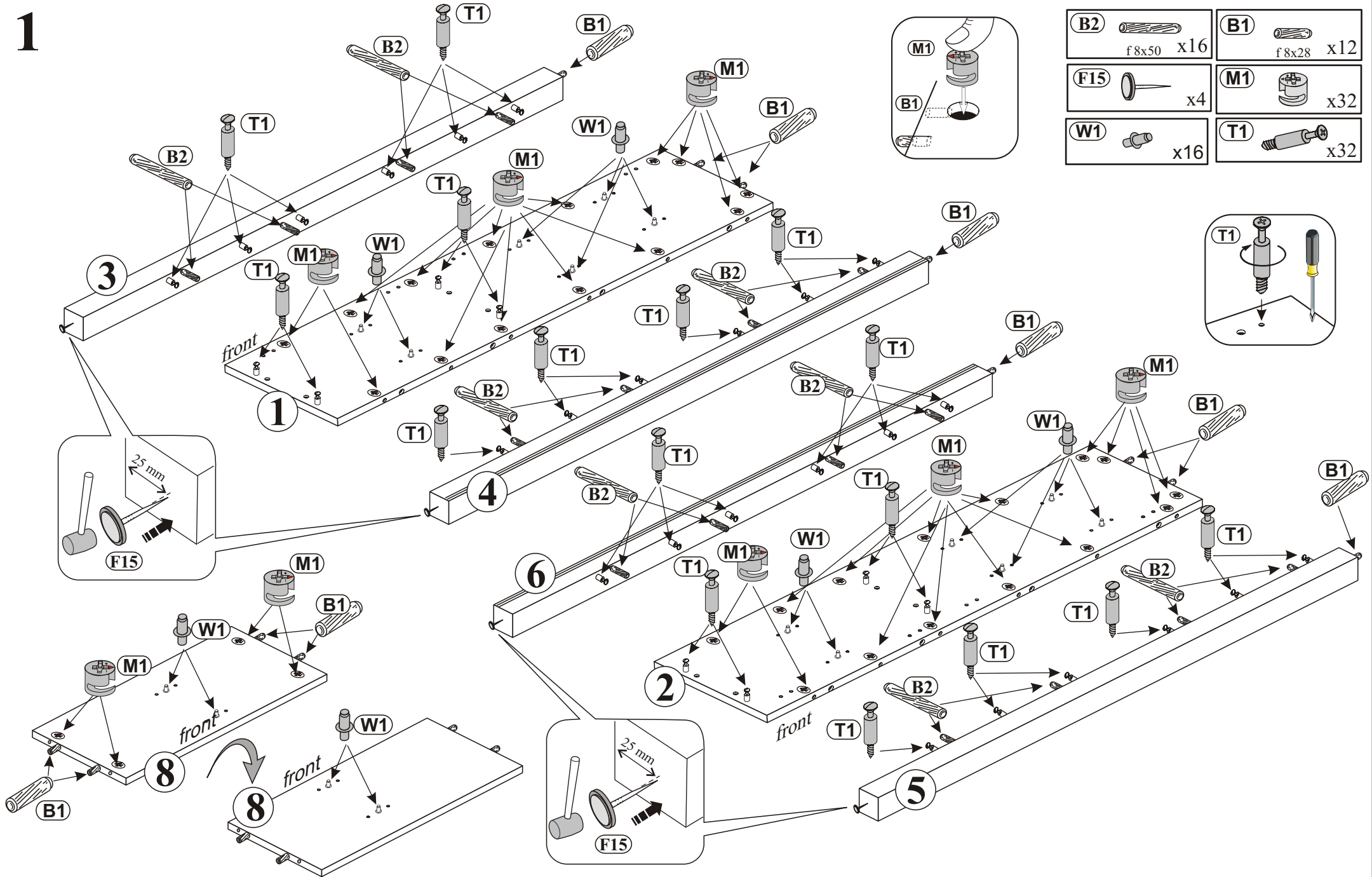

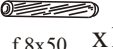

- | | |
|---|---|
| NR 2
Y1 26
Kr15 x8
Y5 x8
H2
S8 x16
4x13 mm
E3 x16
6,3x13 | NR 1
B1 x20
8x28
B2 x16
8x50 X16
L1 x1
Leim
M1 x40
T1 x40 |
| NR 3
U61 x4
A14 x8
M4x23 | W1 x16
F1 x4
S4 x12
3,0x20 |
| NR 4
J11 x1
P13 2x
3,5x13 | J23 x22
C2 x44
F15 x4 |



1

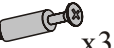

B2	 f 8x50 x16	B1	 f 8x28 x12
F15	 x4	M1	 x32
W1	 x16	T1	 x32

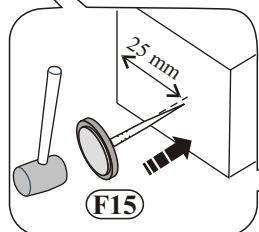
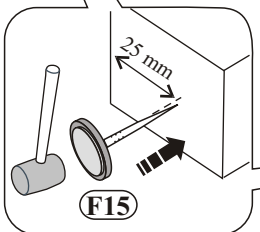
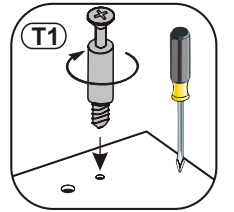

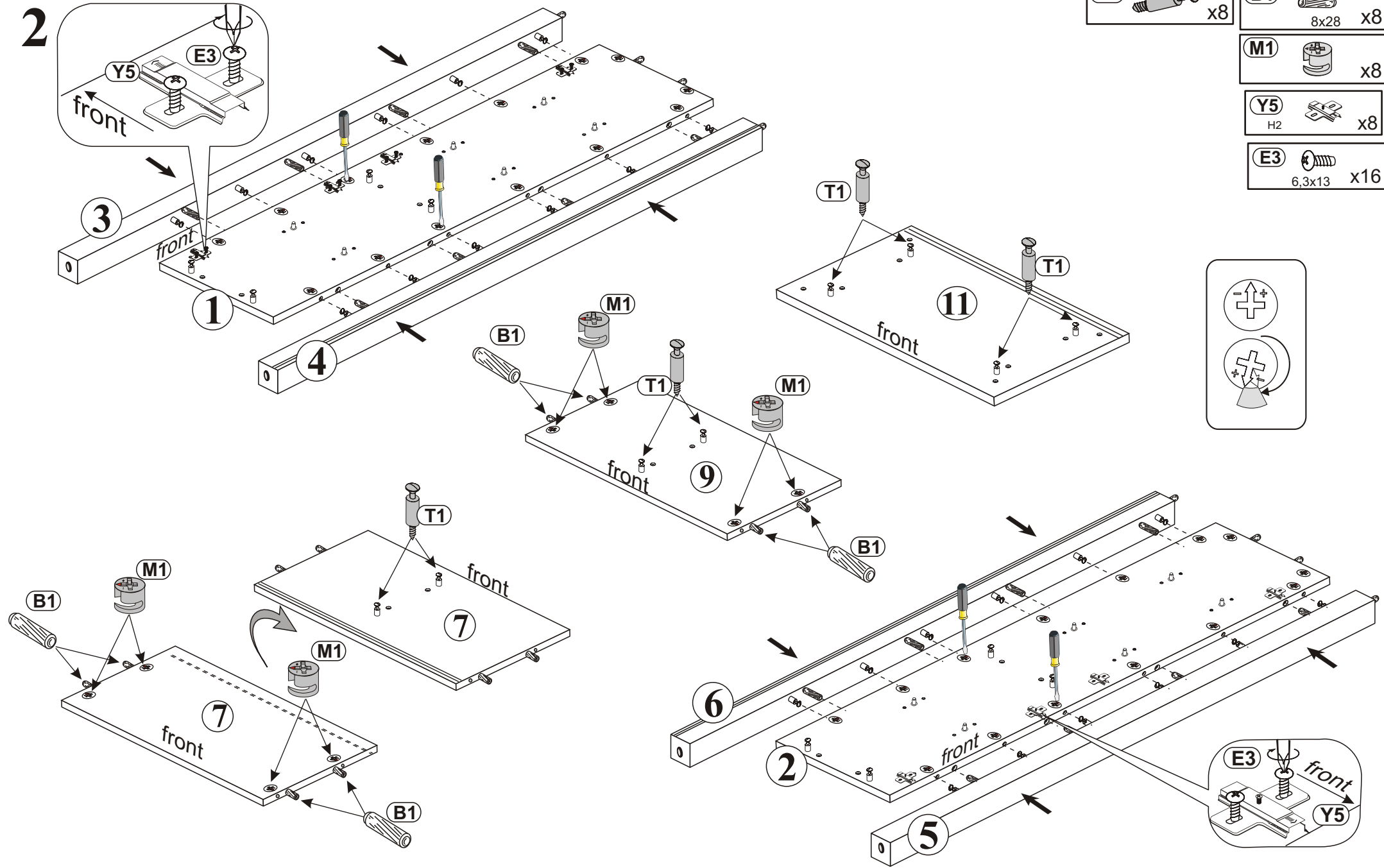
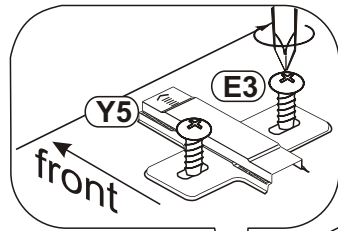

2



T1  x8

B1  8x28 x8

M1  x8

Y5  H2 x8

E3  6,3x13 x16

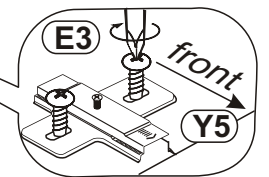
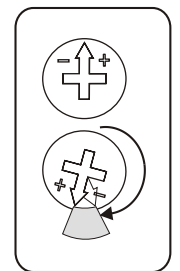

3

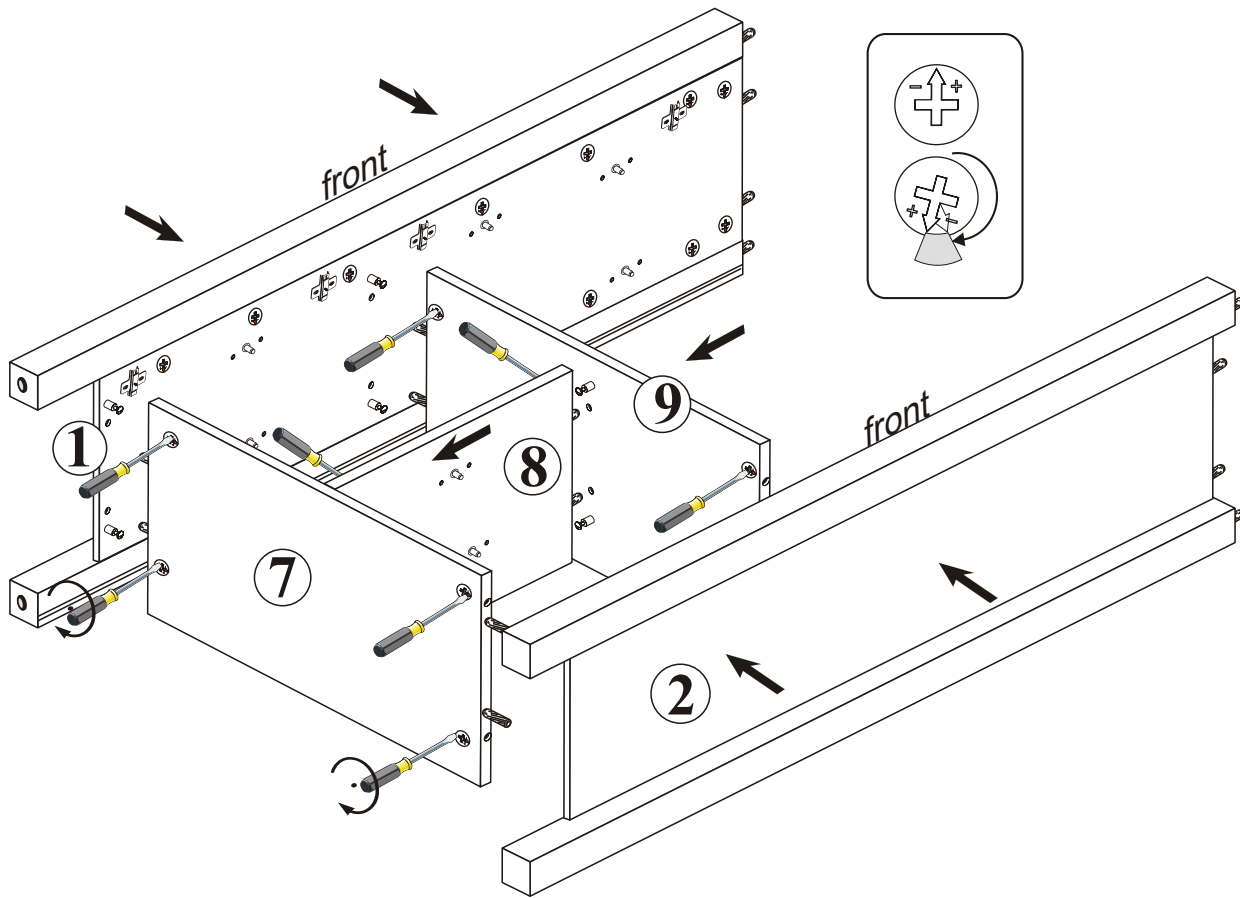

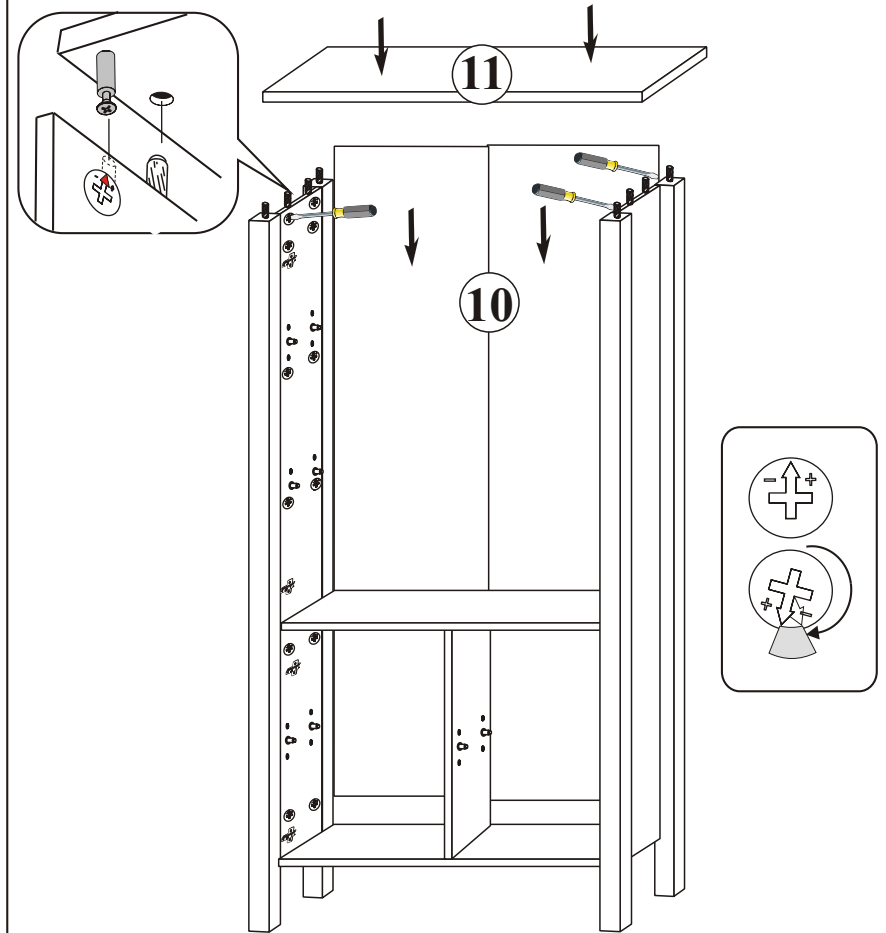

4

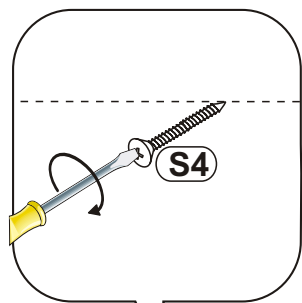

5





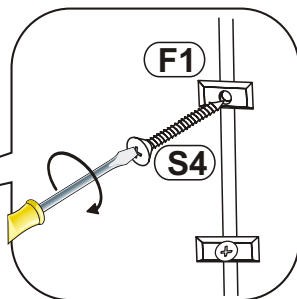
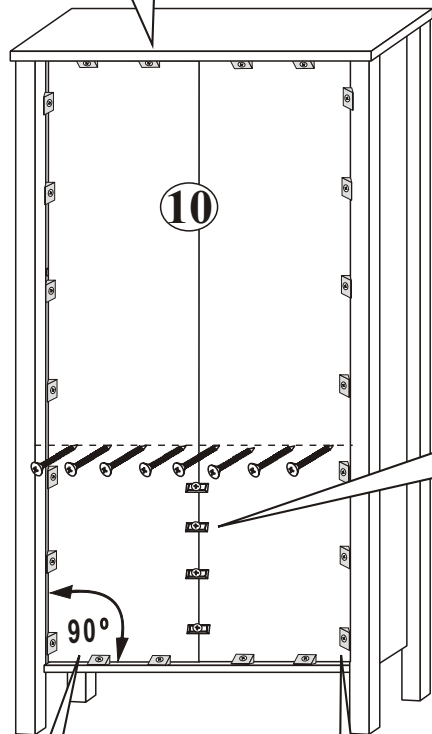

- F1**  x4
- S4**  3,0x20 x12
- J23**  x22

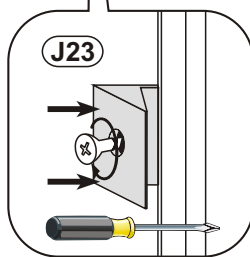
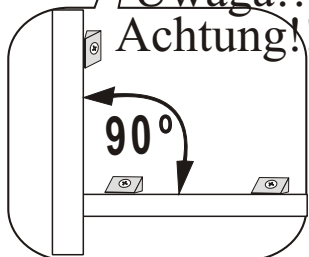

Uwaga!!
Achtung!!



6

- Y1**  26
Kr15 x4
- S8**  4x13 mm x8
- C2**  x8
- U61**  x2
- A14**  M4x23 x4

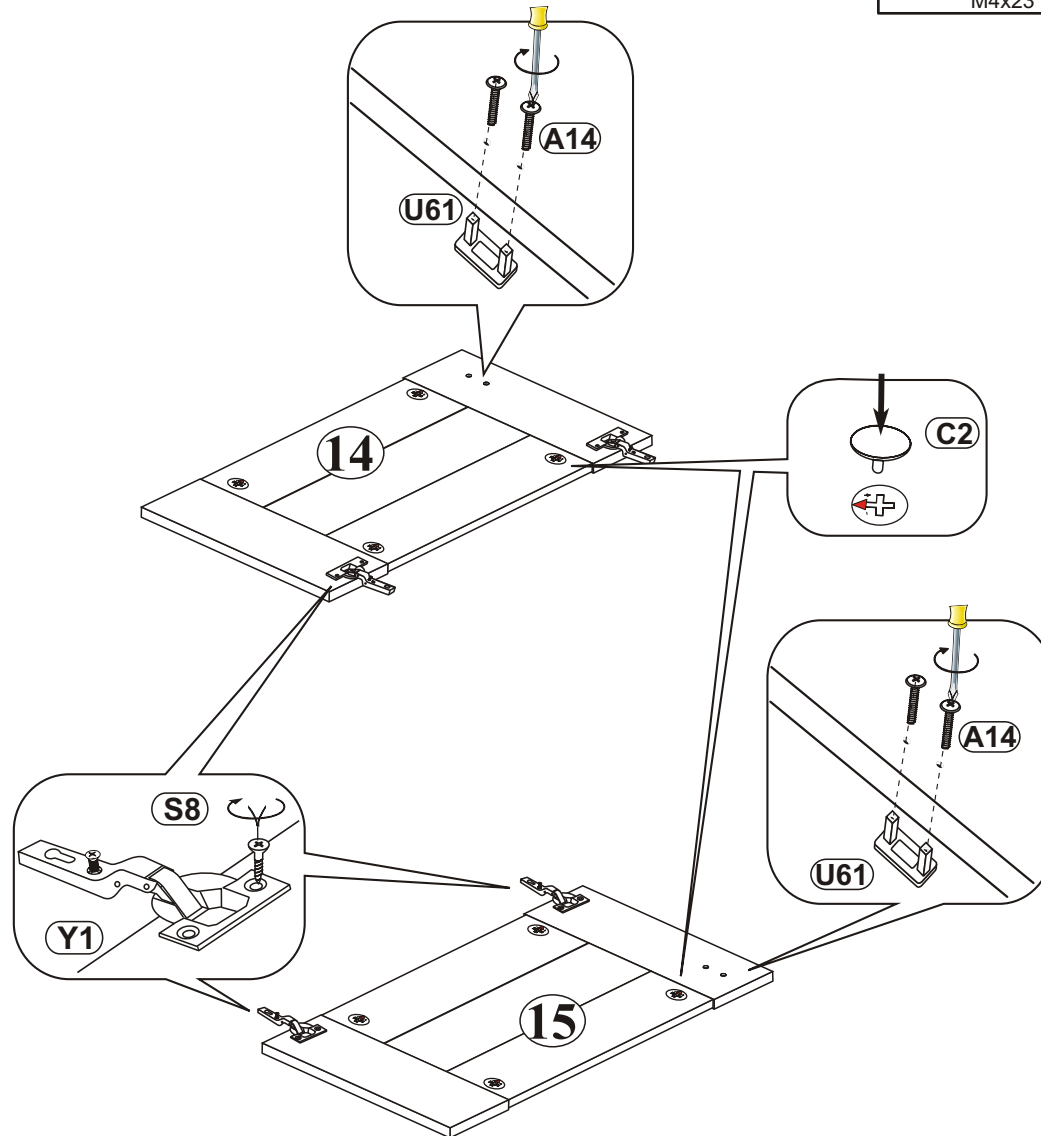

7

- Y1** Kr15 26 x4
- S8** 4x13 mm x8
- U61** x2
- A14** M4x23 x4

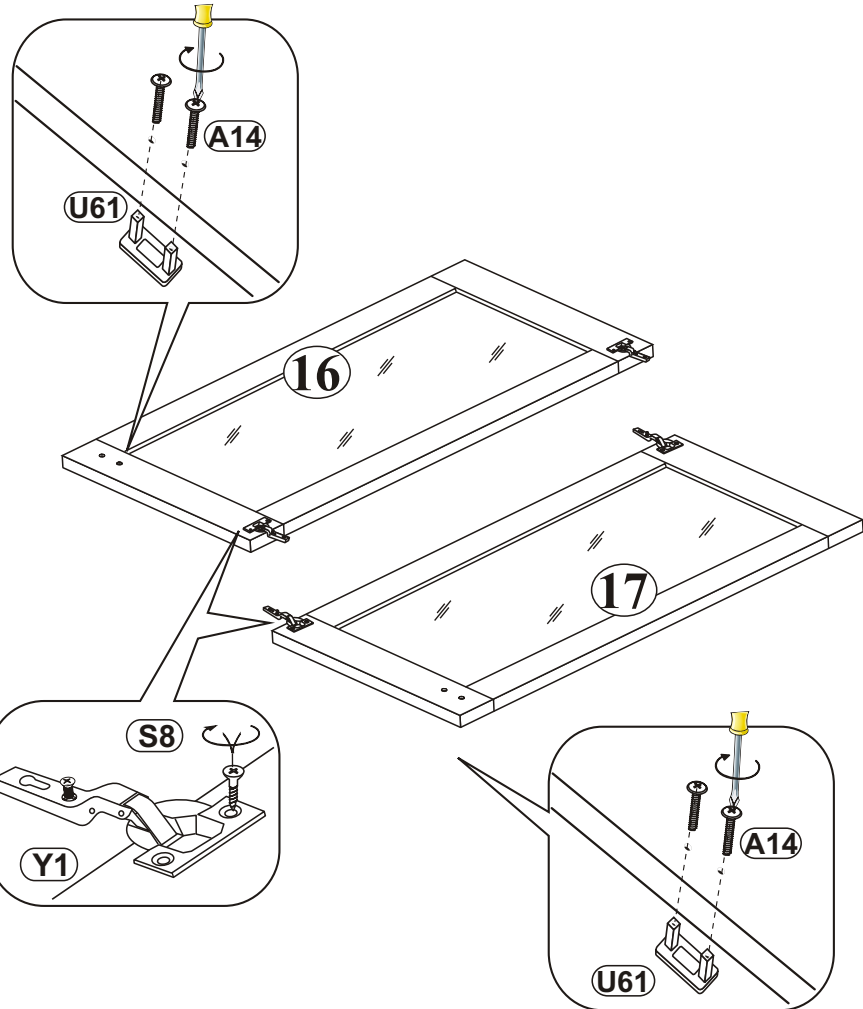

8

- J11** x1
- P13** 3,5x13 2x

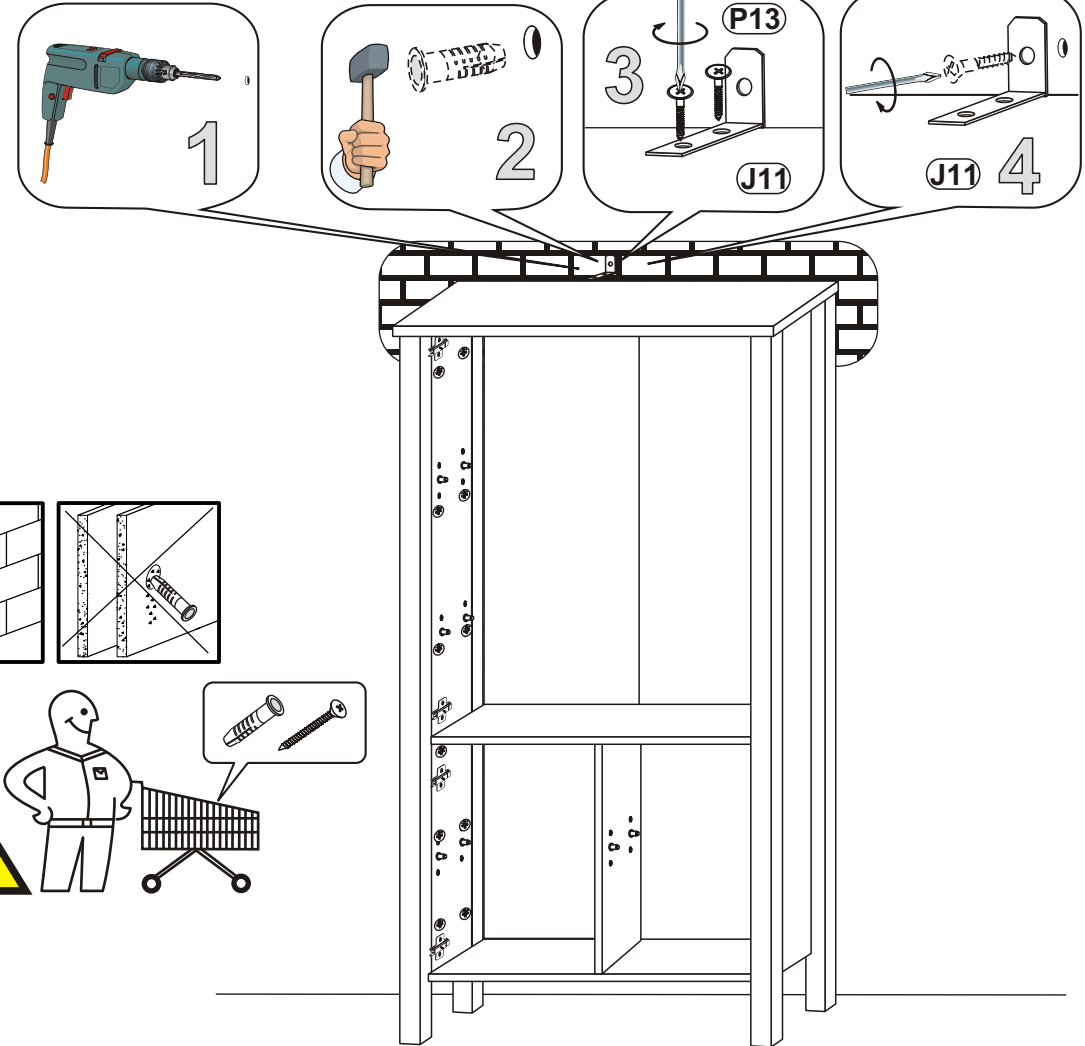

9

