

KENTAKI

S132-SZF5D2S

A	B	C	D	A	B	C	D		
1	S132-020	1600	496	6/6	14	S132-503	603	80	3/6
2	S132-021	496	188	5/6	15	S132-505	603	80	3/6
3	S132-022	380	496	5/6	16	S132-534	578	270	4/6
4	S132-023	1600	496	6/6	17	S132-535	578	270	4/6
5	S132-135	1992	540	1/6	18	S132-536	1594	80	3/6
6	S132-136	1992	540	1/6	19	S132-921	2018	993	1/6
7	S132-137	379	540	2/6	20	S132-922	439	498	2/6
8	S132-138	379	540	1/6	21	S132-923	2018	502	1/6
9	S132-139	1598	540	1/6	22	ZN1-502	80	38	2/6
10	S132-225	1512	562	2/6	23	ZS2-509	500	120	2/6
11	S132-226	1512	562	2/6	24	ZS2-510	500	120	2/6
12	S132-318	1470	540	2/6	25	ZS2-5579	428	120	2/6
13	S132-319	481	536	2/6	26	dr-969	969	30	2/6

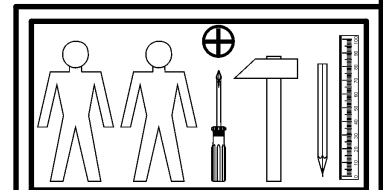
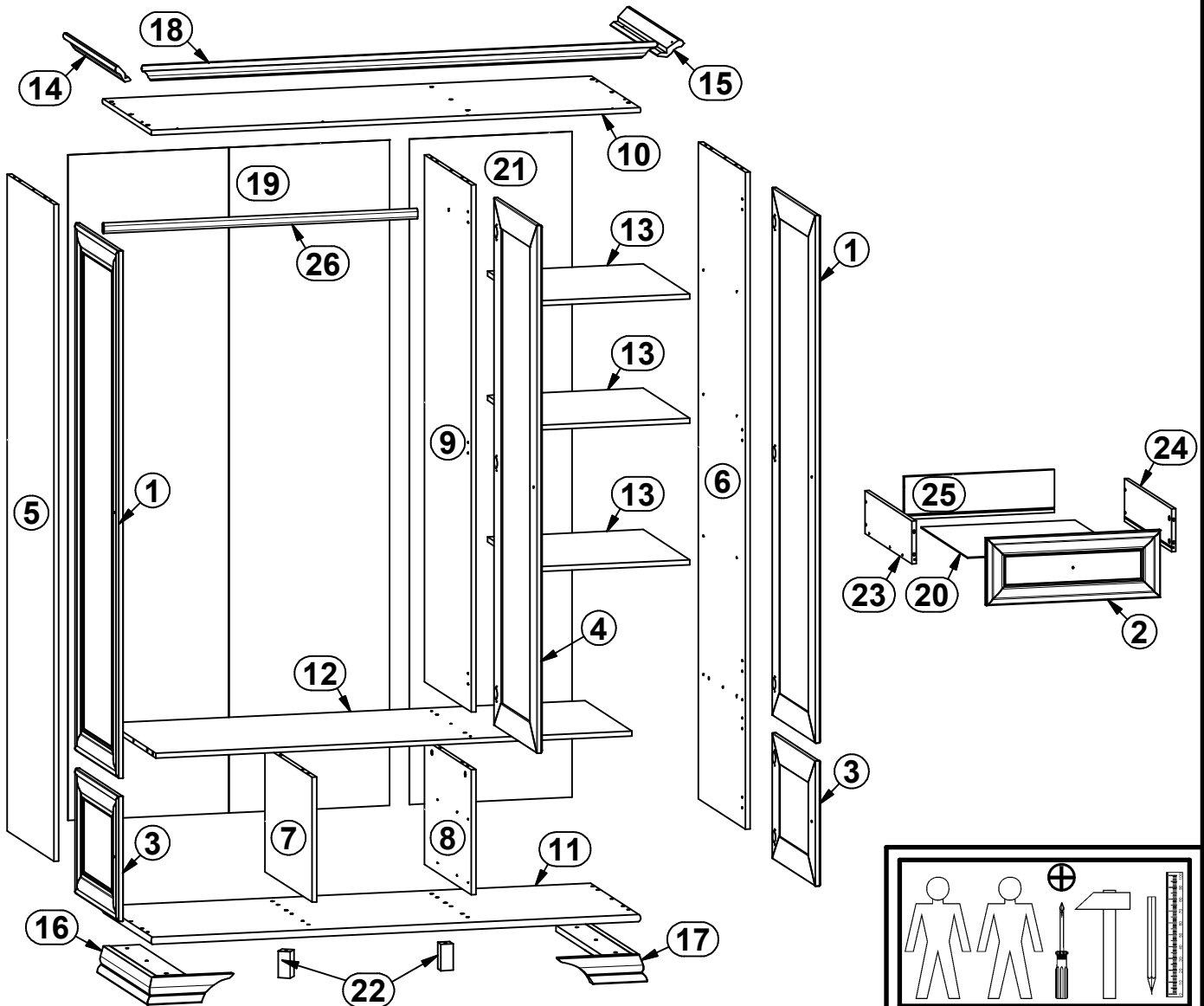
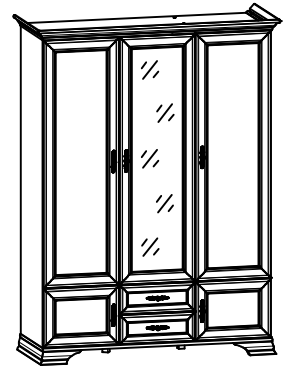

13x a44	13x b19	7x c35\1	7x c35\2	12x d1	2x d4	1x p38	12x e19	26x e2
6x e26	12x e3	23x e8	24x f1	8x f25	2x j29	5x j11	130x l1	2x n1
2x n40	2x p1	8x p8	4x p46	26x p51	13x r1	8x r15	21x r42	3x s2
2x w26\CL	2x w26\CR	2x w26\DL	2x w26\DR	1x z1	1x n26\1			

1 

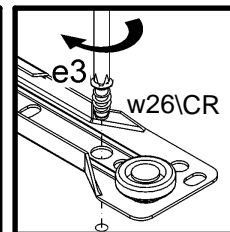
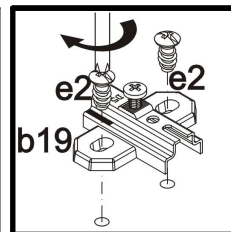
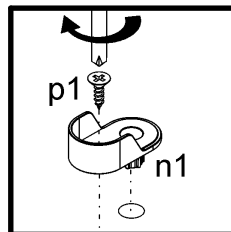
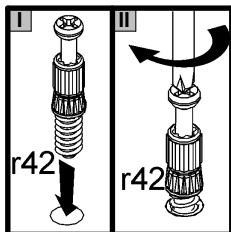
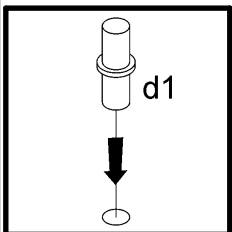
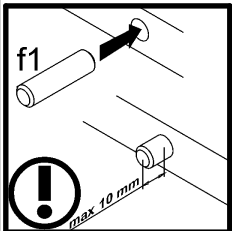
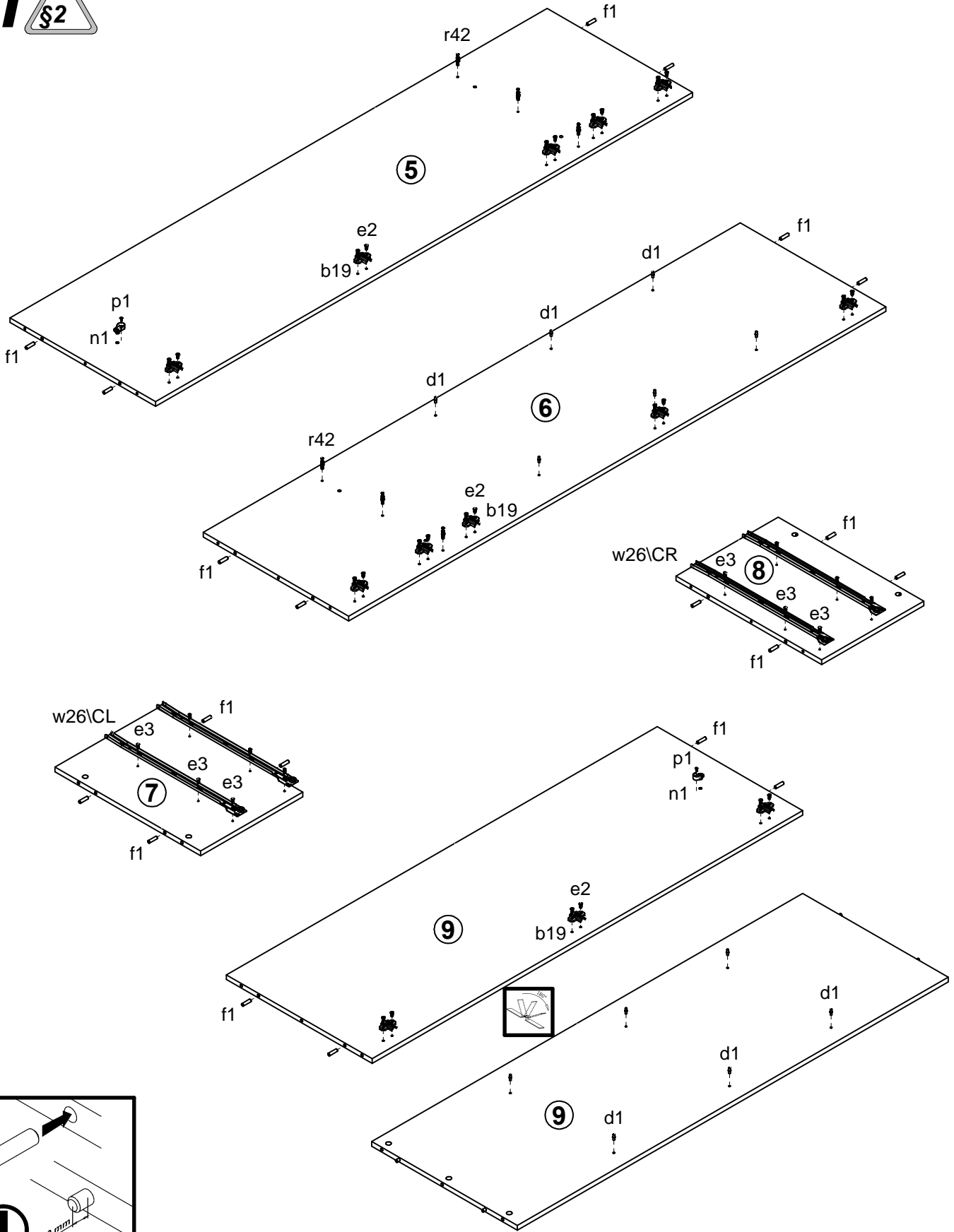

2

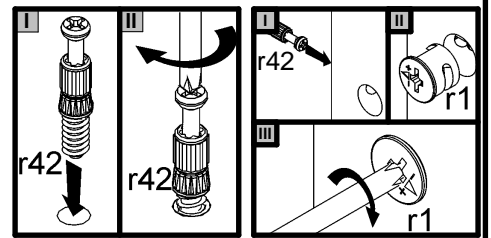
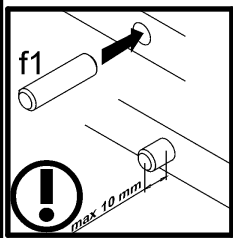
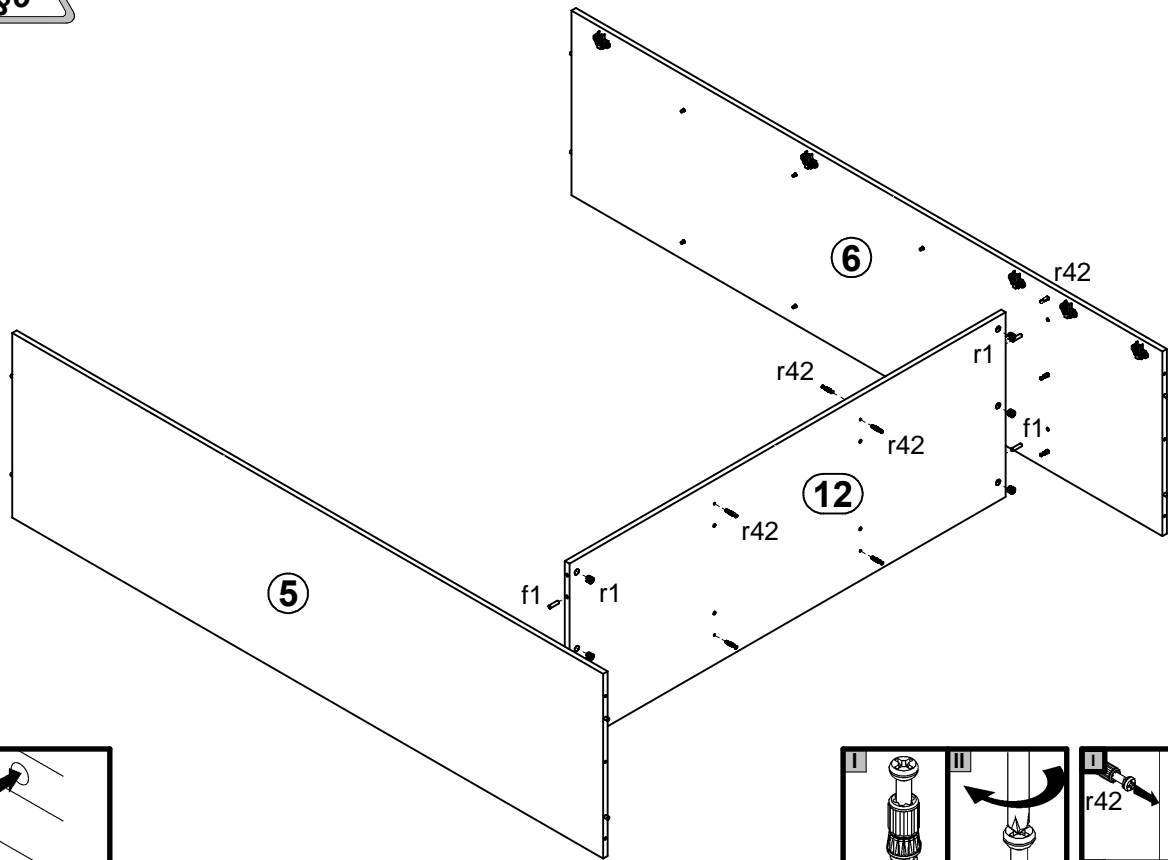

3

