

Modellname: **ALASKA**
Nazwa modelu:

Modellreihe: **P9 -- AS**
Numer modelu:

Type: **K6**
Typ:

Blatt Nr **1** von: **7**
Strona z:

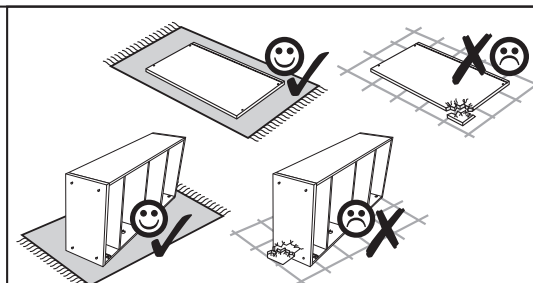
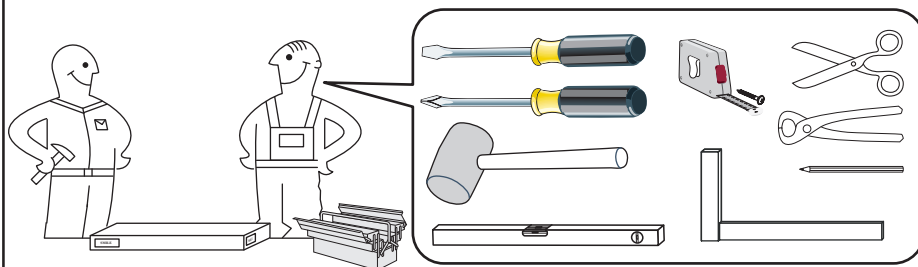
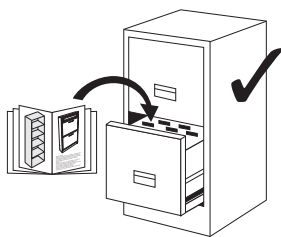
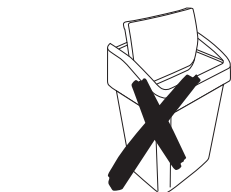
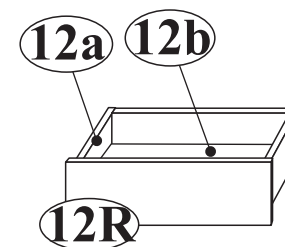
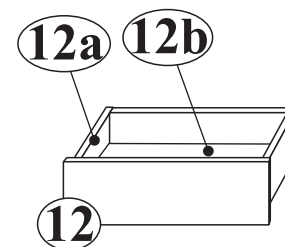
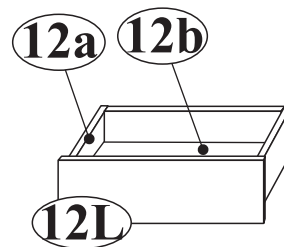
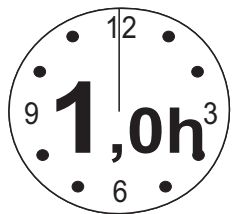
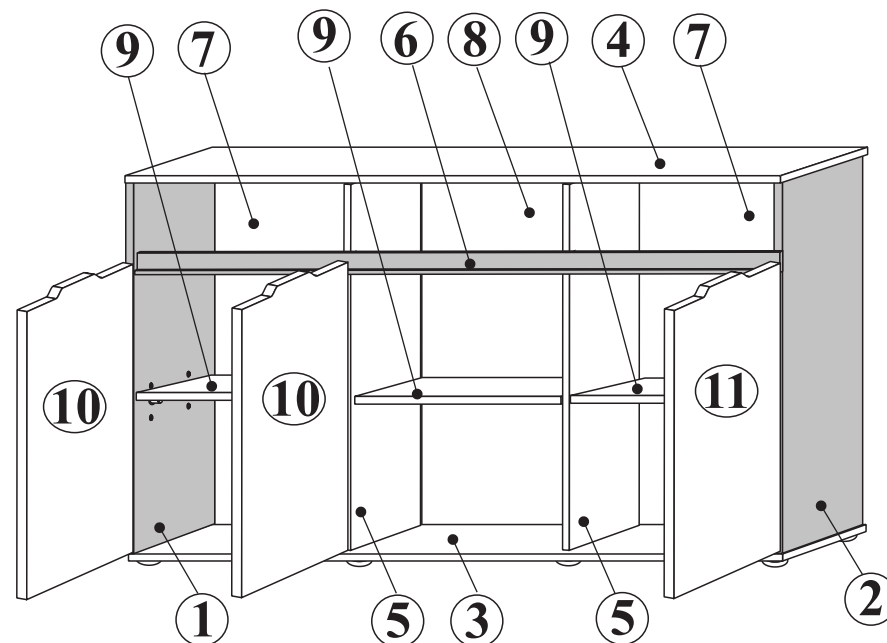
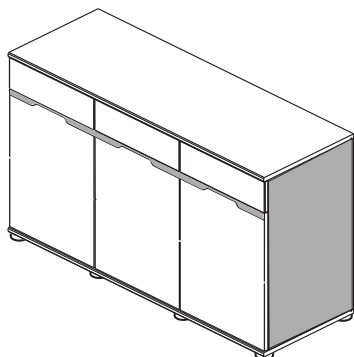



NR 1

L1  x1

C2  x8

M1  x16

T1  x16

K3  x2

B1  ϕ 8x28 x20

W1  x12

S3  3,5x13 x4

F1  x6+6

S4  3,0x20 x12

J23  x24

NR 2

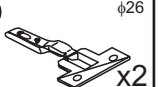
Y2  ϕ 26
Kr8 x2

Y5  H0 x2

S8  4x13 mm x4

NR 3

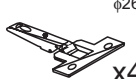
Y0  ϕ 26
Kr0 x4

Y5  H0 x4

S8  4x13 mm x8

NR 4

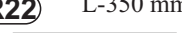
R22 L-350 mm
 x3L/3R

E1  6x11 x6

E2  6x8 x12

S3  3,5x13 x6

P3  3,0x13 x12

NR 5

F10  x8

P4  4x25 x8



1

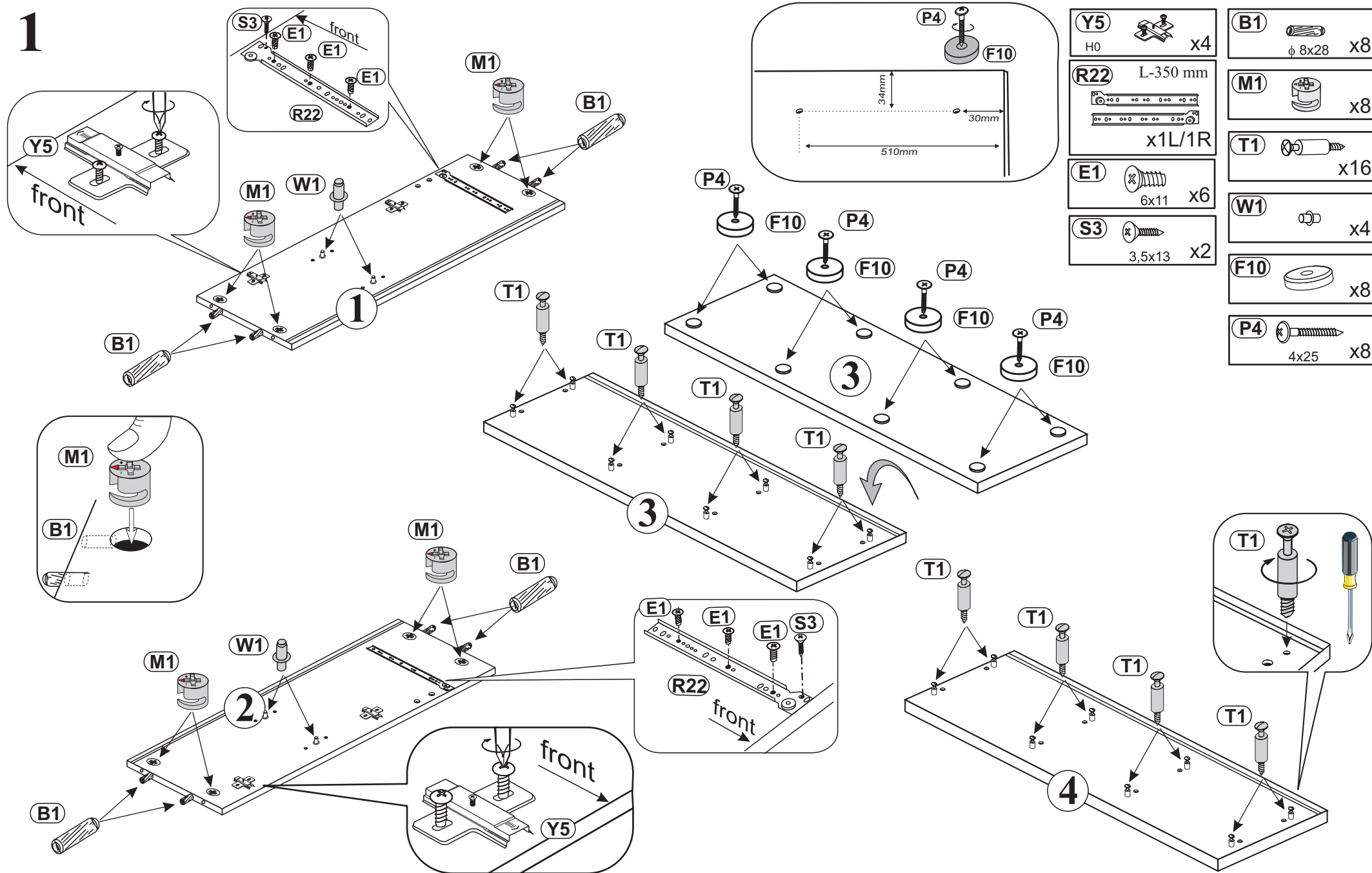

2

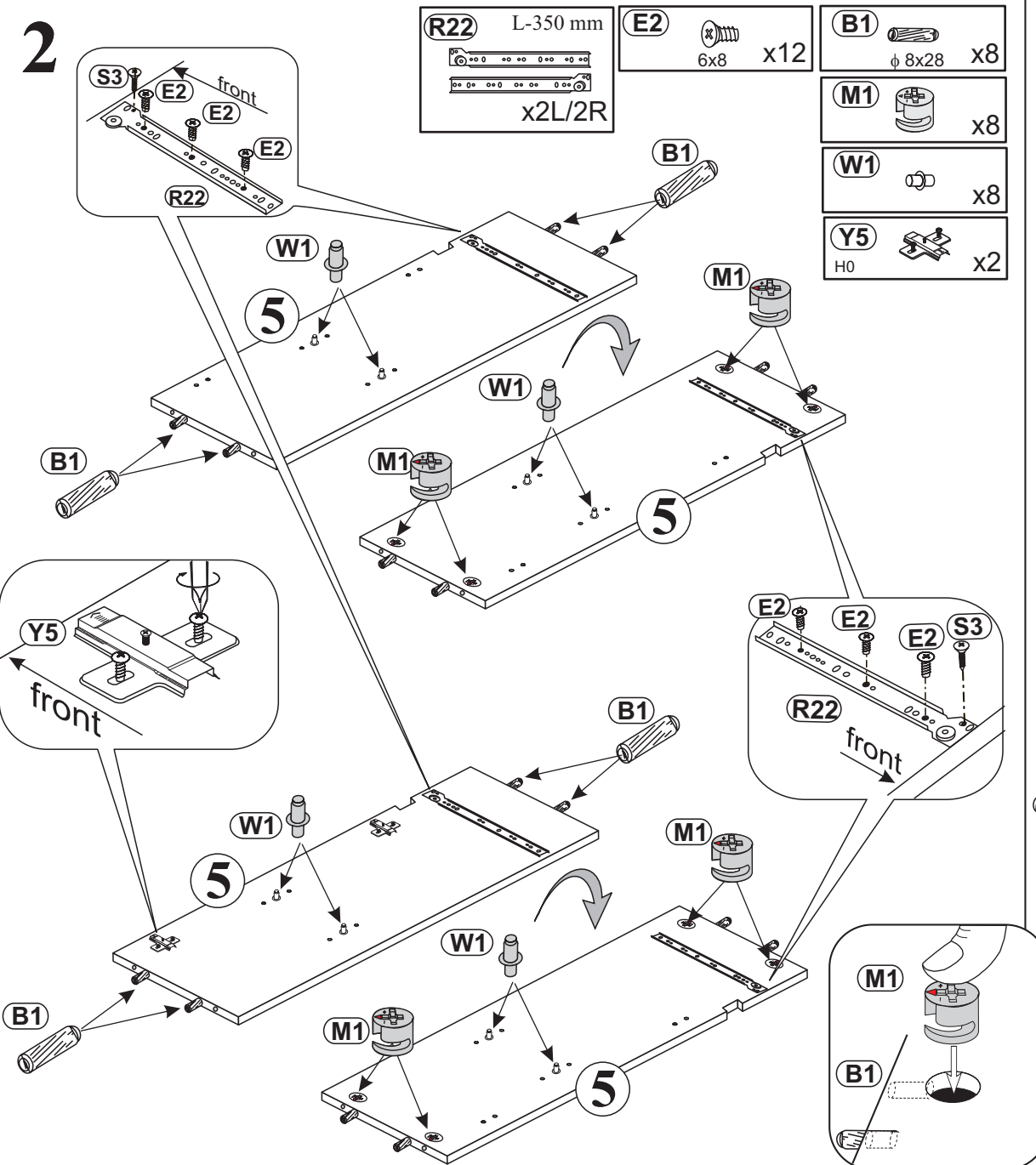

3

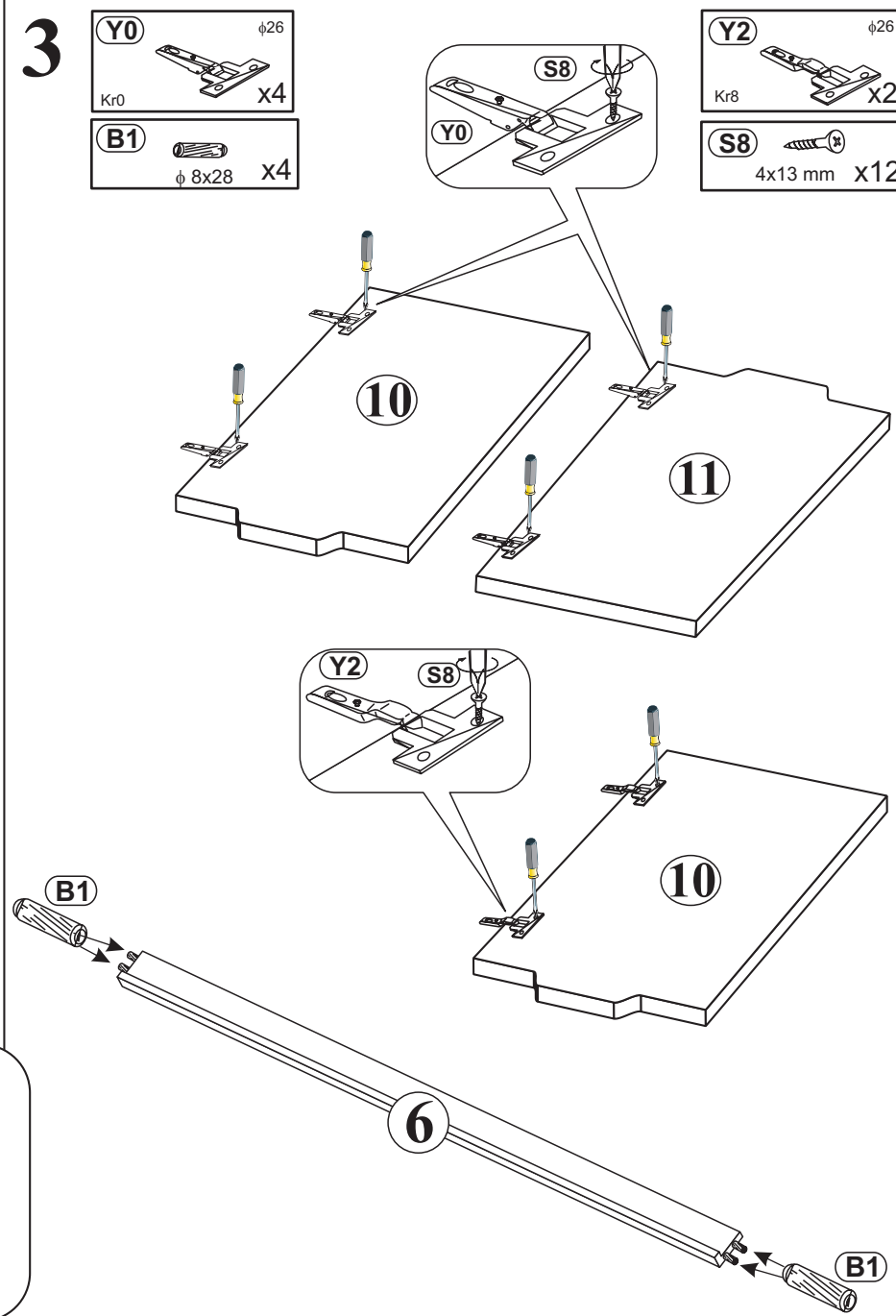

4

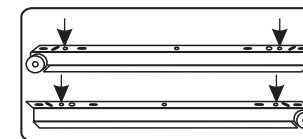
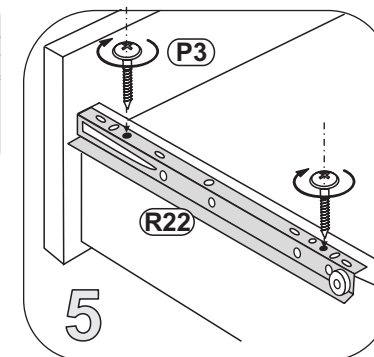
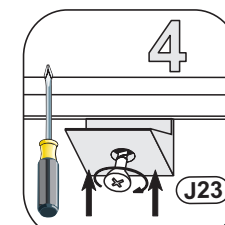
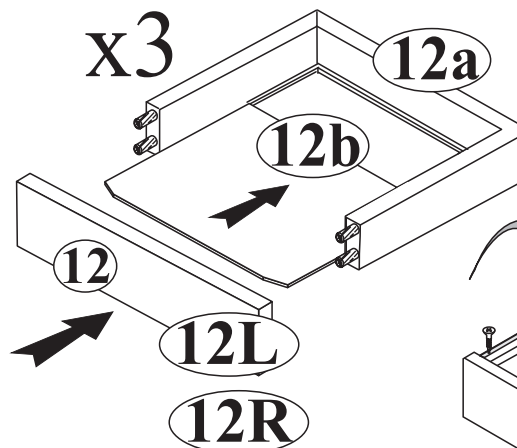
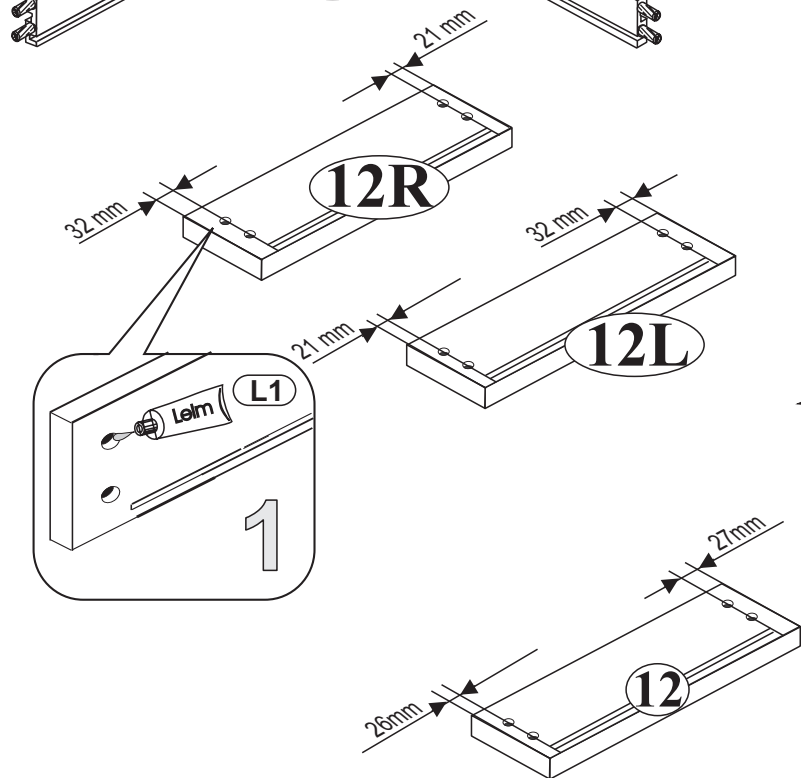
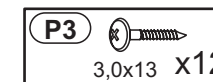
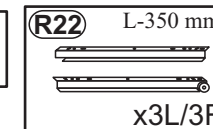
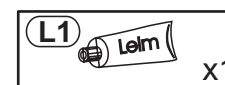
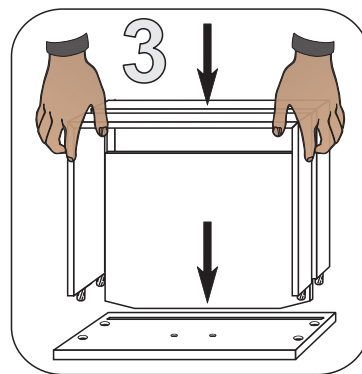
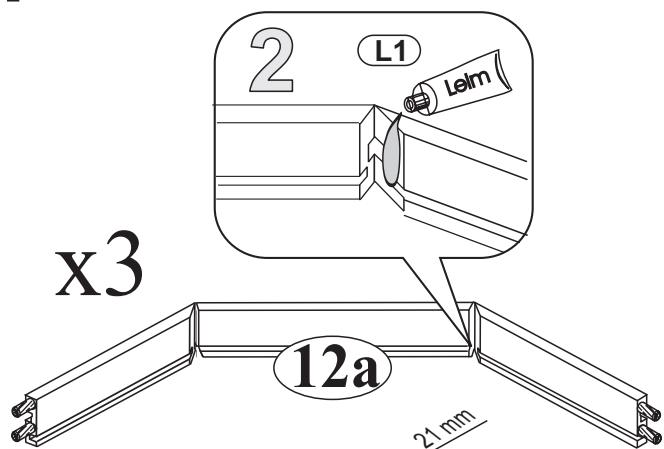

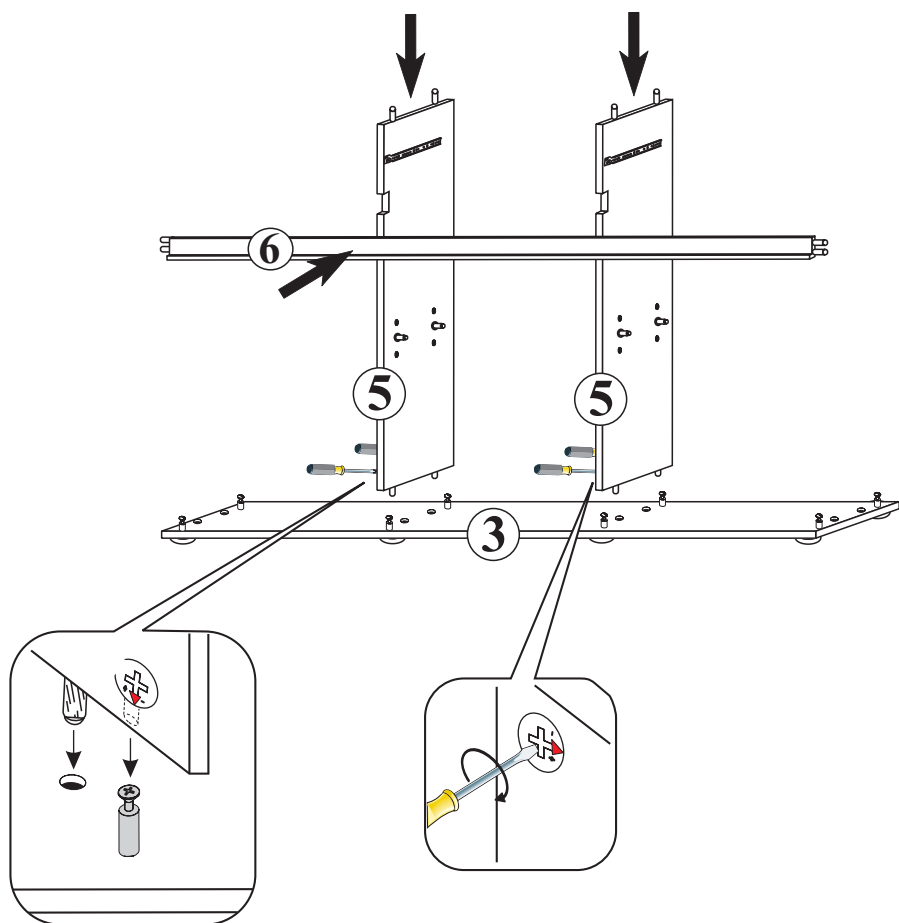

5

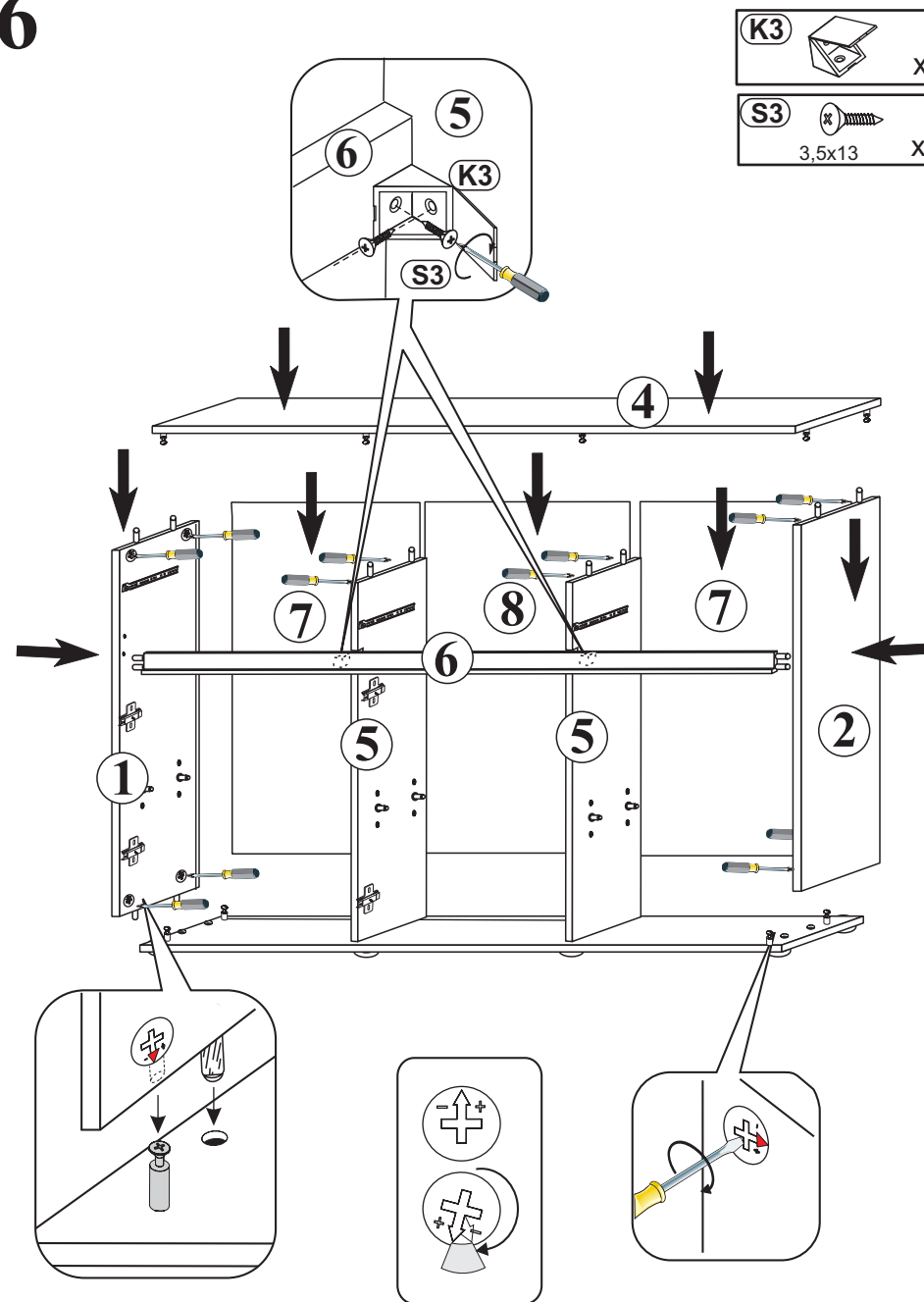

6



7

- F1**  x12
- S4**  3,0x20 x12
- J23**  x18

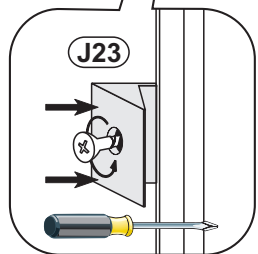
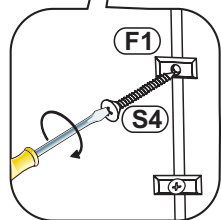
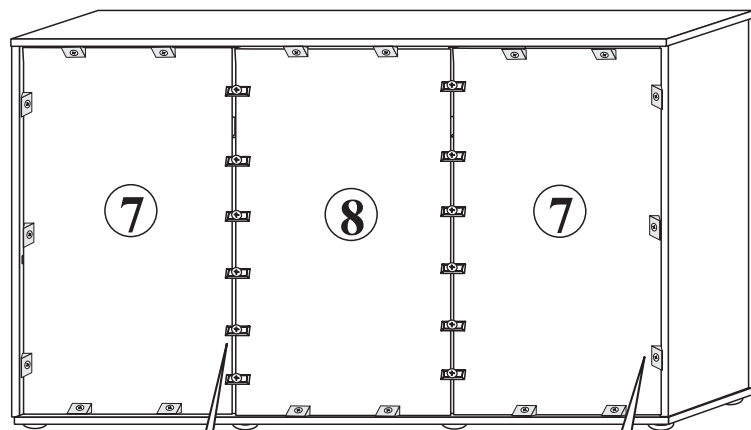

8

